

NSK

Air Powered Tooth Polishing System

Prophy-Mate **neo**

OPERATION MANUAL

Please read this Operation Manual carefully before use, and file for future reference.



OM-T0309E 002

MADE IN JAPAN

CE 0197

Thank you for purchasing NSK's Prophy-Mate neo.

This product is a tooth cleaning handpiece.

Make sure to read this operation manual carefully before use, and keep it in a place where it can be referred to at any time.

Contents



Features	1
△ Safety instructions and danger items	2
1. Type of Prophy-Mate neo	3
2. Standard Packaging Content	4
3. Operation	5
4. Care After Use	8
5. Cleaning and Sterilization	12
6. Troubleshooting	14

Features

- The 360° twist free swivel joint at the handpiece end and the hose end of the powder case enables smooth operation even under high air pressure. The handpiece swivels so easily that access to hard to reach areas becomes effortless. The Prophy-Mate neo is designed to minimize strain and fatigue even during prolonged operation.
- The choice of nozzle between 60° and 80° enables easy reach of all tooth surfaces and unobstructed vision.
- Because the major part of the enclosed 'FLASH pearl' cleaning powder is calcium carbonate it is suitable to be used for patients who should have a limited intake of sodium.
- The enclosed 'FLASH pearl' powder is very efficient in removing stains and plaque, therefore procedures can be carried out quickly and efficiently benefiting both the operator and the patient.

Cautions for handling and operation

- Read these cautions carefully and use only as intended or instructed.
- Safety instructions are intended to avoid potential hazards that could result in personal injury or damage to the device. Safety instructions are classified as follows in accordance with the seriousness of the risk.

 WARNING	A hazard that could result in bodily injury or damage to the device if the safety instructions are not followed.
 CAUTION	A hazard that could result in light or moderate bodily injury or damage to the device if the safety instructions are not followed.

WARNING

- This instrument is for use by dentists or hygienists only.
- Do not use on the following patients
<FLASH pearl and Cleaning powder>
 - 1) Those with respiratory diseases.
 - 2) Those with pathologically deep periodontal pockets (6mm or more) or mucosal lesion. By a long-time jet to soft tissue or near salivary glands, powder air may enter, and this may cause emphysema in very rare cases.
 - 3) Those with grave ulcers in digestive organs.
 - 4) Those with hepatic dysfunction.
 - 5) Those with lung or cardiac disturbance or ventilatory impairment.
 - 6) Those with damage or abnormality in the oral cavity.
 - 7) Those with hyperemia, hemorrhage, or inflammation in the oral cavity.
 - 8) Those who tend to develop an inflammation or sores in the oral mucous membrane.
 - 9) Those with allergies.
 - 10) Those wearing contact lenses.
 - 11) Depending on the patient's constitution, allergy symptoms or stomatitis may be caused in very rare cases. If such symptoms are detected, stop using the product immediately.
<Cleaning powder only>

Those who require restriction on sodium intake (hypernatremia, gestoses, renal deficiency, chronic respiratory disease, and chronic diarrhea). Excessive administration of sodium could be caused by using "Cleaning Powder", which results in worsening of the conditions.
- During use, both the operator and the assistant should always wear protective glasses and protective face masks. The patient should wear protective glasses. Also, it is recommended to use high volume suction during the operation of Prophy-Mate neo. In case any powder gets in the eyes wash out immediately with lots of water and consult an ophthalmologist.
- Never directly jet to the cementum on the roots of teeth, decalcified enamel, filling materials, margins of prosthetic appliances and filling materials, crowns, etc.
- Apply Vaseline, etc., to the patient's lips to prevent drying or chapping at the corners of the mouth.
- Higher air pressure could cause the powder case and powder case cover to crack or fracture, which leads to injury.



CAUTION

- Make sure your compressed air is dry and clean. Water or oil content mixed in the air may cause internal solidification of cleaning powder.
- Securely tighten the cap of the powder case and never open the powder case cap during operation.
- Before connecting the Prophy-Mate neo make sure that all connections are totally dry.
- Use NSK-made cleaning powder. We shall assume no liability for any failure caused by the use of another company's cleaning powder.
- Fill powder case with one sachet of FLASH pearl at a time. Discard any remaining cleaning powder in the case after use to avoid blockages.
- Make sure you use new unopened sachets of FLASH pearl only. Opened sachets attract moisture and the powder will clog in the handpiece.

1. Type of Prophy-Mate neo

Hose Connection Type	Model	
	Gray	White
NSK PHATELUS Coupling	PMNG-PTL-P	PMNW-PTL-P
NSK QD-J Coupling Type	PMNG-QD-P	PMNW-QD-P
ISO 4-hole Joint	PMNG-M4-P	PMNW-M4-P
ISO 2-hole or 3-hole Joint	PMNG-B2-P	PMNW-B2-P
KaVo® MULTIflex® or MULTIflex® LUX Coupling	PMNG-KV-P	PMNW-KV-P
W&H® Roto Quick® Coupling	PMNG-WH-P	PMNW-WH-P
Bien-Air® Unifix® or Unifix® L Coupling	PMNG-BA-P	PMNW-BA-P
Sirona® Quick Coupling	PMNG-SR-P	PMNW-SR-P

KaVo® and LULTIflex® are registered trademarks of Kaltenbach & Voigt GmbH & Co., Germany.

W&H® and Roto Quick® are registered trademarks of W&H dentalwerk Burmoos GmbH, Austria.

Bien-Air® and Unifix® are registered trademarks of Bien-Air Dental S.A., Switzerland.

Sirona® is a registered trademark of Sirona Dental System GmbH, Germany.

2. Standard Packaging Content

Prophy-Mate neo handpiece	1	
Nozzle	1 each for 60° and 80°	(The 60° nozzle is already fitted on the handpiece.)
Powder case	1	
Maintenance kit		
Nozzle wire	Large: 1 for the root of the nozzle	Small: 1 for the tip of the nozzle and inner nozzles
Cleaning wire	1 (for other uses)	
Cleaning Brush	1	
Cleaning Powder (FLASH pearl)	5 sachets	
Nozzle Wrench	1	
Oil	1	
Blower Nozzle	1	(can be connected to the coupling to supply dry air to remove powder residues on the Prophy-Mate neo and its components)
Spare parts		
Powder case cover	2	(One is fit to the powder case.)
O-rings (Handpiece end)	1 set	
O-rings (Coupling end)	1 set	(NSK PHATELUS coupling only)

* The maintenance kit and spare parts are stored in the accessory case.

Part name

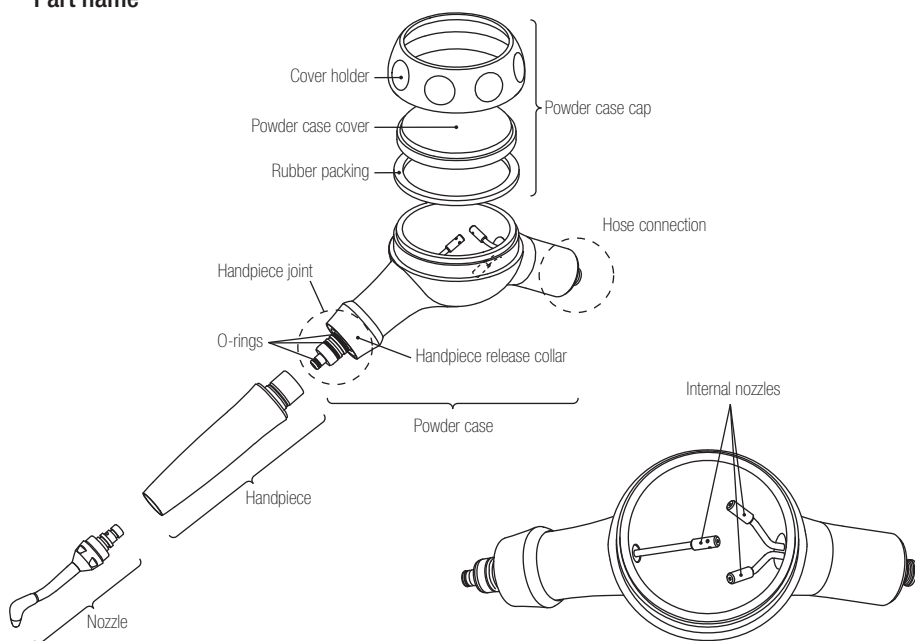

3. Operation



WARNING

- Avoid long-time continuous use, and allow the patient to rinse at appropriate times.
- Never hit or bang the powder case and powder case cap as this may cause the powder case or powder case cap to scratch or crack.
- Never take the Prophy-Mate neo apart during operation. Never pull the handpiece release collar or the coupling release during operation. Attempting to do this may cause components of the Prophy-Mate neo and the cleaning powder to fly off.
- Use this product at the correct air pressure only.
- Thoroughly dry the Prophy-Mate neo and all its components inside and out before use.



CAUTION

- Be very careful to avoid cleaning powder entering anybody's mucosal areas (eyes, nose etc) other than the oral cavity. Also, protect the face with a towel, etc., or protective glasses, etc., to prevent entry of cleaning powder into eyes.
 - * If the patient wears contact lenses, the contact lenses should be taken out before treatment.
- If chemicals, oils, etc., adhere to the powder case cover, wipe them off immediately. Leaving them as they are will cause breakage.

3-1 Air Pressure

Set the air pressure at the handpiece hose connection at 0.25 - 0.35 MPa (2.5 - 3.5 kgf/cm²).



WARNING

Higher air pressure could cause the powder case and powder case cap to crack or fracture, which leads to injury.

3-2 Connecting Powder case to Handpiece Hose



CAUTION

Before connecting each part, thoroughly dry the coupling, handpiece, hose joint section of the powder case, inside of the powder case, and nozzle.

Also, perform idle running with air alone to blow off any internal water.

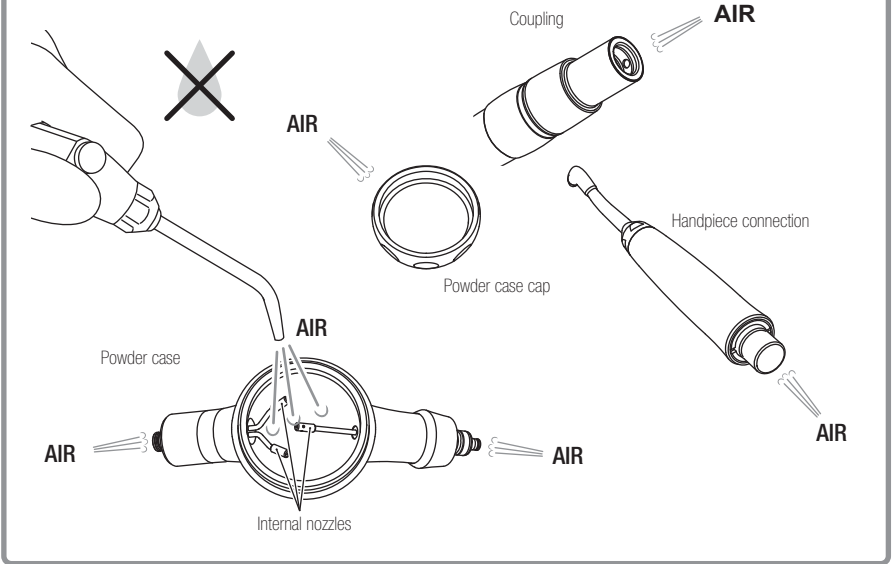

Connect the hose to the powder case.

- PMNG-PTL-P, PMNW-PTL-P

Connect FM-CL (2,3,4-hole), PTL-CL-4HV (6-pin), or PTL-CL-FV (5-hole) coupling to the handpiece hose. In case you have any of these couplings mounted on the handpiece hose, you can just simply click the Prophy-Mate neo handpiece to the coupling.

- 4-Hole, 3-Hole, or 2-Hole type powder case (PMNG/W-M4-P, PMNG/W-B2-P)

Connect the powder case directly to the corresponding handpiece hose. Fasten the hose nut tightly.

- Use with Other Handpiece Manufacturers' Coupling

(PMNG/W-QD-P, PMNG/W-KV-P, PMNG/W-WH-P, PMNG/W-BA-P, PMNG/W-SR-P)

Check with the instruction manual of the coupling you have and connect Prophy-Mate neo accordingly

3-3 Connecting handpiece to Powder case

Pull back the handpiece release collar on the powder case and push handpiece straight on to the connection. Let go off the release collar once handpiece is in place. (Fig.1) Once connected gently pull handpiece to ensure proper connection.

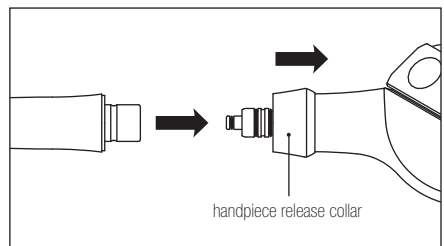

Fig. 1

3-4 Filling Cleaning Powder

Open one sachet of cleaning powder and fill into powder case.

Always tighten powder case cap after opening and closing. (Fig. 2)

■ When using bottle of FLASH Pearl (Option)

Open the Powder Case Cap, and fill the powder into until Internal Nozzle (Fig. 3) and firmly tighten the bottle cap.

*FLASH pearl (Bottle Type Contains 300gms x 4)
Order No. Y900698*



Fig. 2

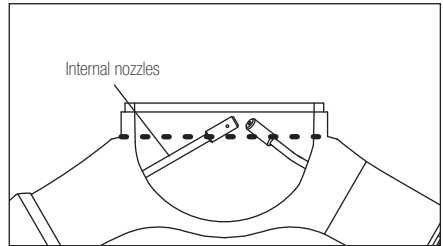

Fig. 3



CAUTION

- Always dispose off left over powder. Do not store any open sachets for later use. Powder in opened sachets will attract moisture and will clog powder channels.
- Use NSK-made cleaning powder. Other companies' cleaning powder different in particle size may cause clogging and not deliver full performance.

3-5 Use

After filling the powder case, operate the Prophy-Mate neo over the spittoon for 2 to 3 seconds to ensure good flow of powder and water before using it on the patient. Use the nozzle 3 to 5mm away from the tooth surface at angles of 10 to 60 degrees. (When using PROPHY MATE cleaning powder, use at angles of 60 to 90 degrees.)

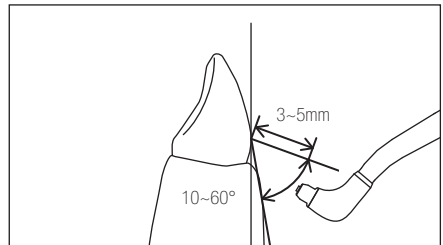

Fig. 4



CAUTION

In order to prevent the patient from swallowing large amounts of cleaning powder, make sure you use high volume suction and cotton wool rolls in conjunction with the Prophy-Mate neo, avoid long continuous use and allow the patient to rinse at appropriate times.

4. Care After Use



WARNING

- If organic solvents, etc., adhere to the powder case cap, this may result in breakage.
- The powder case cover will deteriorate over time under the influence of ultra violet rays and other environmental factors and is therefore considered a consumable item. Replace powder case cover every six months.
- Always thoroughly clean the powder case, the powder case cap and the thread on the powder case and the powder case cap. Do this once a week and check the powder case cover and powder case cover for cracks and the scratches.
- Always replace the powder case cap or the powder case immediately should you detect any cracks. If such a case is used as it is, the powder case cover may break, and this may cause injury by its fragments.
- In order to prevent the Prophy-Mate neo from clogging put the entire instrument in an ultrasonic bath once a week. (See 5-1 Ultrasonic cleaning.)



CAUTION

- In the case of failure, make sure to contact your distributor for repairs.
- After use always clean thoroughly internally and externally and ensure all powder residues are removed and the instrument is totally dry for storage.
- Never lubricate Prophy-Mate neo.(However, lubricate the O-rings with the enclosed turbine oil (See 4-4 Lubrication.))

4-1 Discard of powder

- 1) Open the powder case cap, and remove the remaining cleaning powder. (Fig. 5)

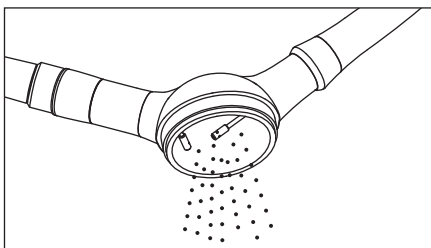

Fig. 5

- 2) Perform idle running with air alone to discharge water and powder in the nozzle (Fig. 6)

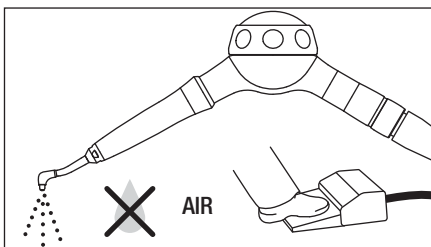

Fig. 6

- 3) Blow off the powder remaining in the powder case with air. (Fig. 7)
- 4) Wipe the nozzle and handpiece with a soft cloth saturated in alcohol to remove saliva and other physical contamination.

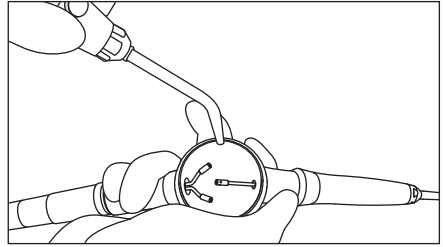

Fig. 7

4-2 Removal of powder from the powder case, handpiece and nozzle

- 1) Remove the powder case from the hose.
- 2) Pull back the handpiece release collar and remove handpiece
- 3) Remove the nozzle with the nozzle wrench (Fig. 8)
- 4) Fit the enclosed blower nozzle to the coupling and attach to the handpiece. Run idle with no water more than 5 sec. to clear lines. (Fig. 9)

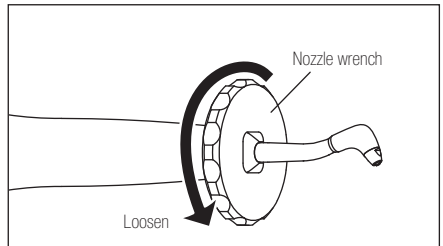
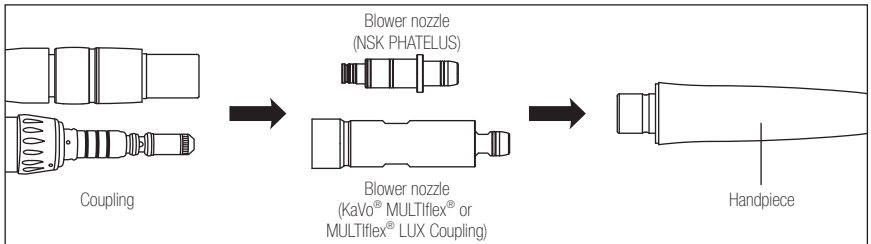

Fig. 8



* Blower nozzles for other brands couplings are also available.

Fig. 9

Use the blower nozzle in the same way to clear the lines in the Prophy-Mate neo nozzle. Blow from the far end of the nozzle.



CAUTION

When performing idle running hold components tightly.

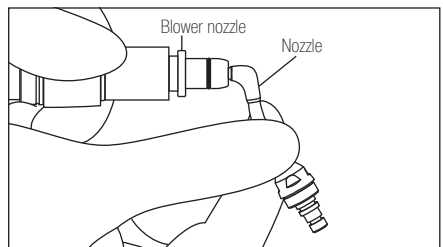

Fig. 10

4-3 Cleaning and washing

- 1) Carefully clean the inside of the joint section of the handpiece and the O-ring section of the powder case with the attached cleaning brush. (Fig. 11)

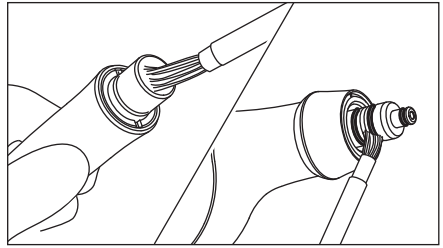

Fig.11

- If powder adheres to the O-ring section, remove the O-rings, and carefully clean the O-rings and grooves. (Fig. 12)

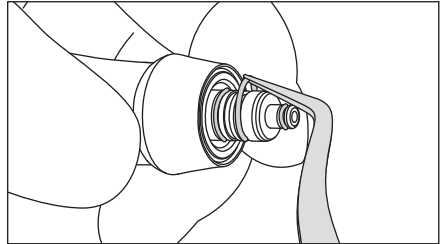

Fig.12

- 2) Remove the rubber packing and disassemble the powder case cap. (Fig. 13)

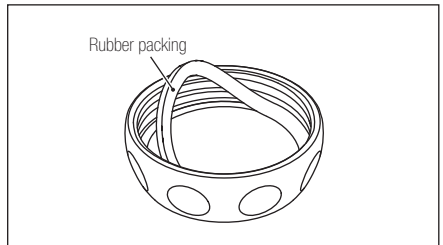

Fig. 13

- 3) Wash away the cleaning powder adhering to the inside of the powder case/powder case cap under running water. (Fig. 14)

- 4) Dry and assemble the powder case cover, rubber gasket and cover holder.

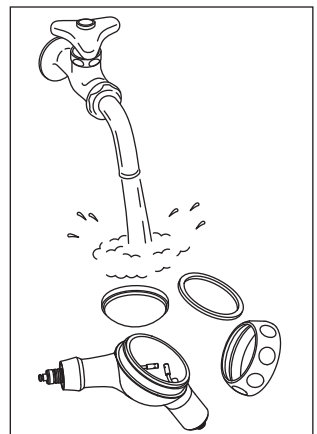

Fig.14



CAUTION

If cleaning powder remains in the powder case, powder will cake up, and this may cause clogging.

4-4 Lubrication

- 1) Dry the O-ring section of the powder case, apply a drop of the enclosed turbine oil and rub it in with your finger. (Fig. 15)
- 2) Perform autoclave sterilization.

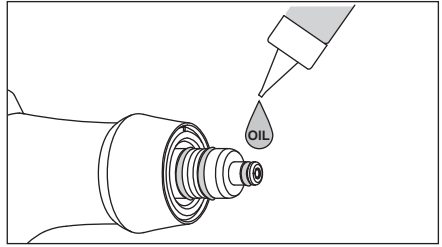

Fig.15

⚠ CAUTION

If lubrication of the O-rings is neglected the joint between the powder case and handpiece may be damaged. Powder case and handpiece may no longer swivel freely and the joint may leak.

5. Cleaning and Sterilization



Only the handpiece part of the Prophy-Mate neo can be washed in a thermodisinfectior. Do not wash the Powder case or powder case cap in a thermodisinfectior

5-1 Ultrasonic cleaning

CAUTION

Make sure you clean the Prophy-Mate neo in an ultrasonic bath once a week to prevent the instrument from clogging.

- 1) Perform disassembly and cleaning. (See 4-1 Discard of powder to 4-3 Cleaning and washing.)
- 2) Pass the attached nozzle wrench from the tip of the nozzle, loosen the nozzle, and remove the nozzle from the handpiece.
- 3) Perform ultrasonic cleaning of the handpiece, powder case, and nozzle with hot water.
- 4) After cleaning, blow off water drops on all parts with dry air.
- 5) Perform reassembly in reverse order to disassembly.
- 6) Connect powder case without the powder case cap to the hose and run idle to clear internal lines from water.

CAUTION

- When fitting the nozzle, first screw in the nozzle by hand until it is lightly tightened, and then securely tighten it with the nozzle wrench.
- In particular, thoroughly dry the inside of the powder case.

5-2 Sterilization

- Autoclave sterilization is recommended. Sterilization is required first time you use and after each patient.
- All the parts are autoclavable.

■ Autoclaving procedure

- 1) Perform disassembly and cleaning. (See 4-1 Discard of powder to 4-4 Lubrication.)
- 2) Insert into an autoclave pouch. Seal the pouch.
- 3) Autoclavable up to a max. 135°C.
ex.) Autoclave for 20 min. at 121°C, or 15 min. at 132°C.
- 4) Keep the handpiece in the autoclave pouch to keep it clean until you use it. For use, perform reassembly in reverse order to disassembly.

* Sterilization at 121°C for more than 15 minutes is recommended by EN13060 or EN ISO17665-1.



CAUTION

- Before use, thoroughly dry all parts.
- Remove the powder case cap from the powder case, and perform autoclave sterilization. Sterilization with the powder case cap on may cause breakage of the cover.
- Autoclave sterilization together with chemical-adhering instruments will cause the plating to peel off or affect the internal parts. Be careful so as not to allow entry of chemicals in the autoclave sterilizer.
- Since there are cases where the set temperature may be exceeded locally near the heater in the autoclave, never place the product near the heater.
- Do not wipe with, or clean or immerse in, high acid water or sterilizing solutions.

6. Troubleshooting

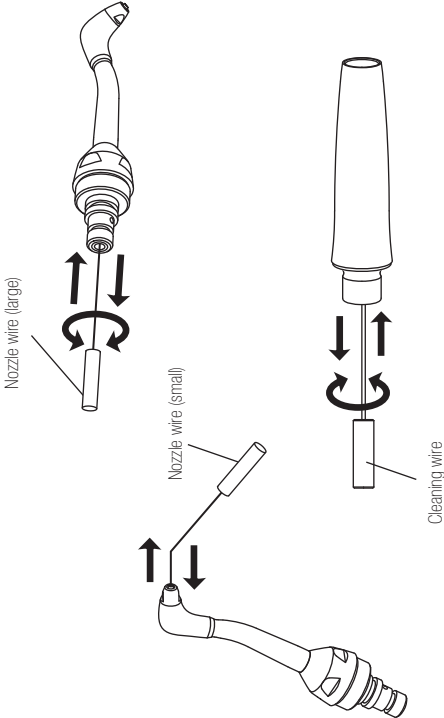
Symptom	Check item	Probable cause	Remedy
Air and powder do not come out.	Air and powder come out of the handpiece joint section when the handpiece is removed and air is supplied.	The handpiece is clogged with powder.	<p>Loosen the nozzle with the attached nozzle wrench, and remove the nozzle from the handpiece. Clean the tip of the nozzle with the attached nozzle wire (small), and its root with the nozzle wire (large). Also, clean the inside of the handpiece with the cleaning wire. In the case of not passing regardless of the above cleaning, perform ultrasonic cleaning with hot water. (See 5-1 Ultrasonic cleaning.)</p>  <p>The diagram consists of three parts. The top part shows a 'Nozzle wire (large)' being used to clean the tip of a nozzle. The middle part shows a 'Nozzle wire (small)' being used to clean the root of a nozzle. The bottom part shows a 'Cleaning wire' being used to clean the inside of a handpiece.</p>

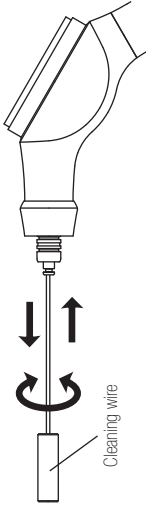
	Air and powder do not come out of the powder case even when the handpiece is removed and air is supplied.	The powder case is clogged with powder.	<p>Pass the cleaning wire through the hole in the center of the tip of the handpiece joint section of the powder case while rotating it, and also clean the inlets of the inner nozzles with the nozzle wire (large). In the case of not passing powder and air regardless of the above cleaning, perform ultrasonic cleaning with hot water. (See 5-1 Ultrasonic cleaning.)</p> 
Water leaks from between the handpiece and powder case.	Check the O-rings at the handpiece joint section of the powder case.	The O-ring is damaged.	Replace the O-ring(s) at the handpiece joint section of the powder case apply a drop of the enclosed turbine oil and rub it with a finger and others. (See 4-3 Cleaning and washing to 4-4 Lubrication.)
The connection between the powder case and handpiece is hard to swivel.	Check the O-rings at the handpiece joint section of the powder case.	Cleaning powder has entered in the O-ring grooves, making the connection of the coupling section hard.	Remove the O-rings at the handpiece joint section of the powder case, carefully clean the cleaning powder adhering to the grooves and O-rings by using the attached cleaning brush. Then, carefully wipe the handpiece joint section with an alcohol-saturated cloth, apply a drop of the enclosed turbine oil and rub it with a finger or other materials. (See 4-3 Cleaning and washing to 4-4 Lubrication.)

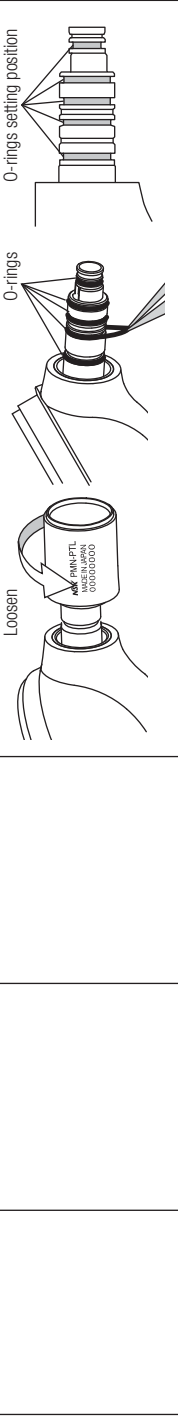
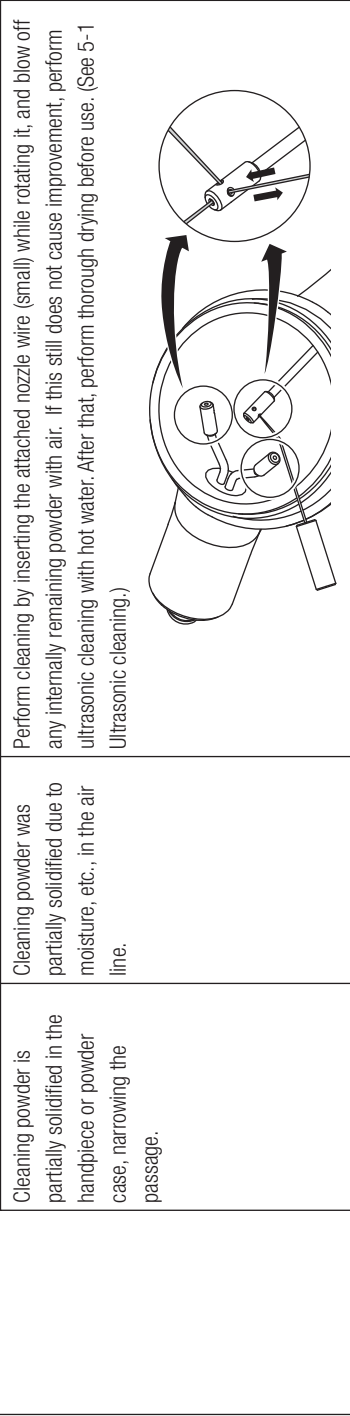
<p>Air and powder come out weakly, and cleaning power is also weak.</p>	<p>Cleaning powder is partially solidified in the container.</p>	<p>Cleaning powder having been left for a long period of time was used.</p>	<p>Replace the cleaning powder with a new one.</p>
<p>Cleaning powder is partially solidified in the handpiece or powder case, narrowing the passage.</p>	<p>Cleaning powder was partially solidified due to moisture, etc., in the line.</p>	<p>Water was mixed in the supply air.</p>	<p>In the case of using a model for PHATELUS coupling, check the O-rings at the coupling joint section for breakage. Replace the O-rings if broken. In the case of models for other than PHATELUS coupling, check the coupling which you use.</p>  <p>Open the drains of the filter and compressor in the air supply circuit, and check for water accumulation.</p> <p>Perform cleaning by inserting the attached nozzle wire (small) while rotating it, and blow off any internally remaining powder with air. If this still does not cause improvement, perform ultrasonic cleaning with hot water. After that, perform thorough drying before use. (See 5-1 Ultrasonic cleaning.)</p> 

* If no symptomatic improvements are made by the above methods, contact your distributor.

NAKANISHI INC. 

www.nsk-inc.com

700 Shimohinata Kanuma-shi Tochigi 322-8666, Japan
TEL : +81 (0)289-64-3380 FAX : +81 (0)289-62-5636

NSK Europe GmbH

www.nsk-europe.de

Elly-Beinhorn-Strasse 8 65760 Eschborn, Germany
TEL : +49 (0)6196 77606-0 FAX : +49 (0)6196 77606-29

NSK France SAS

www.nsk.fr

32 rue de Lisbonne, 75008 Paris, France
TEL : +33 (0)1 56 79 59 80 FAX : +33 (0)1 56 79 59 81

NSK United Kingdom Ltd

www.nsk-uk.com

Office 5, Gateway1000, Arlington Business Park,
Whittle Way, Stevenage, SG1 2FP, UK
TEL : +44 (0)1438 310670 FAX : +44 (0)1438 310671

NSK Dental Spain SA

www.nsk-spain.es

C/ Módena, 43 El Soho-Európolis 28232 Las Rozas,
Madrid, Spain
TEL : +34 91 626 61 28 FAX : +34 91 626 61 32

NSK Oceania Pty Ltd

www.nskoceania.com.au

Unit 22, 198-222 Young St. Waterloo, Sydney,
NSW 2017, Australia
TEL : +61 (0)2 8306 3000 FAX : +61 (0)2 8306 3030

NSK America Corp

www.nskdental.com

1800 Global Parkway Hoffman Estates, IL 60192, USA
TEL : +1 888 675 1675 FAX : +1 800 838 9328

NSK Middle East

www.nsk-inc.com

Room 6EA-701, 7th Floor, East Wing No.6
Dubai Airport Free Zone, PO Box 54316 Dubai, UAE
TEL : +971 (0)4-204-5507 FAX : +971 (0)4-204-5508

NSK Asia Pte Ltd

www.nsk-inc.com

1 Maritime Square, #09-33 HarbourFront Centre,
Singapore 099253
TEL : +65-6376-5018 FAX : +65-6376-0233

Specifications are subject to change without notice.