

SURGERY SYSTEM

NSK

Surgic XT Plus

OPERATION MANUAL

Please read this Operation Manual carefully before use, and file for future reference.



Powerful Partners®



OM-E0454E 001



MADE IN JAPAN



Thank you for purchasing the NSK Surgic XT Plus surgical unit.



We recommend that prior to use, you carefully read this document regarding instructions for use, handling method, or maintenance check so that you can carry on using the unit in the future. In addition, keep this operation manual in a place where a user can refer to it at any given time.

◆ Classification of equipment

- Type of protection against electric shock :
 - Class I equipment
- Degree of protection against electric shock :
 - Type BF applied part 
- Method of sterilization or disinfection recommended by the manufacture :
 - See 8. Sterilization
- Degree of protection against ingress of water as detailed in the current edition of IEC 60529 :
 - Foot Control: IPX8 (Protected against the effects of continuous immersion in water)
- Degree of safety of application in the presence of a flammable anesthetic mixture with air or with oxygen or nitrous oxide :
 - Motor, Foot Control: Category AP Equipment 
- Mode of operation :
 - Continuous operation



Cautions for handling and operation

- Read these safety cautions thoroughly before use and operate the product properly.
- These indicators are to allow you to use the product safely, prevent danger and harm to you and others. These are classified by degree of danger, damage and seriousness. All indicators concern safety, be sure to follow them.

Classification	Degree of Danger or Danger and Seriousness
 WARNING	Explains an instruction where personal injury or physical damage may occur.
 CAUTION	Explains an instruction where minor to medium injury or physical damage may occur.
 NOTICE	Explains an instruction that should be observed for safety reasons.

1. Safety precautions prior to use

Read Handpiece's Operation manual carefully before use.

Intended to Use
Surgic XT Plus is intended for use in dental oral surgery and surgical procedures by qualified personnel.
 WARNING
The system may present a possibility of malfunction when used in the presence of an electromagnetic interference wave. Do not install the system in the vicinity of the device which emits magnetic waves. Turn off the power switch of the Control Unit of this system when an ultrasonic oscillation device or an electrode knife is located in the vicinity is used.
 CAUTION
<ul style="list-style-type: none"> • Surgic XT Plus needs special precautions regarding EMC and needs to be installed and put into service according to the EMC information. • Portable and mobile RF communications equipment can affect Surgic XT Plus. Do not use RF equipment outskirts for the product. • The use of accessories, Motors and cables other than those specified, with the exception of Motors and cables sold by the manufacturer of Surgic XT Plus as replacement parts for internal components, may result in increased EMISSIONS or decreased IMMUNITY of the Control Unit.

- Surgic XT Plus should not be used adjacent to or stacked with other equipment and that if adjacent or stacked use is necessary, the Control Unit should be observed to verify normal operation in the configuration in which it will be used.
- When operating this system always consider the safety of the patient.
- Read this Operation Manual before use, and fully understand the functions of each part for operation key.
- Do not attempt to disassemble the Control Unit /Foot Control / Micromotor nor temper with the mechanism.
- Check for vibration, noise and overheating before use and if any abnormalities are found in use, stop using immediately and contact your dealer.
- Use an electrical outlet that is grounded.
- Do not drop, hit, or subject to excessive shock.
- Do not bend the Irrigation Tube while the water pump is operating. It could cause tube breakage.
- Do not use bent, damaged or sub-standard burs. The Shank could bend or brake.
- Do not exceed the recommended speed.
- After each Operation, be sure to lubricate and sterilize the handpiece as soon as it's cleaned. Blood coagulation can cause corrosion and rusting. However, do not lubricate the Micromotor. Oil could generate excessive heat and cause damage.
- The Control Unit can be cleaned with a moist cloth. Disconnect the power supply before cleaning. The Control Unit and the Foot Control cannot be sterilized by any method.
- When the product is very frequently used, consider the maintenance of a small stock of replaceable parts.
- Do not disconnect the Motor Cord from the motor.
- Do not wipe with or, clean or immerse in, high acid water or sterilizing solutions.
- Using the Micromotor continuously with the light 'ON' for more than 15 minutes will cause heat build up in the Micromotor. In such cases, stop using the Micromotor wait for the light to cool, or use the Micromotor with the light 'OFF'.(X-SG20L, Optic handpiece)



NOTICE

- Turn off the Main Power Switch after each use.
- For service requirements and spare parts contact your dealer.
- The use of NSK genuine pre-sterilized, disposable Irrigation tube Kit is recommended.

	Temperature	Humidity	Atmospheric pressure
Use	Between 0-40°C (32-104°F)	Between 10-85% RH	Between 500- 1060hPa
Store	Between -10-60°C (14-140°F)	Between 10-85%RH	Between 500-1060 hPa

** No moisture condensation in the Control Unit.

** Use at outside of these limits may cause malfunction.

2. Package Contents



* Figure shows the Optic Motor, Optic Handpiece

Item No.	Description	Quantity
①	Control Unit	1
②	Foot Controller with Cord (2m)	1
③	AC Electrical Cord (2m)	1
④	Optic Motor / Non-Optic Motor (With Motor Cord) *	1 ^(*)
⑤	Optic Handpiece / Non-Optic Handpiece *	1 ^(*)
⑥	Irrigation Tube	5
⑦	Coolant Solution Hanger Post	1
⑧	Handpiece Stand	1
⑨	Tube Holder	7

Item No.	Description	Quantity
⑩	Nozzle Holder	1 ^(*)
⑪	Internal Irrigation Nozzle	1 ^(*)
⑫	Y-Connector	1
⑬	Calibration Bur	1
⑭	E-type Spray Nozzle	1
⑮	Cleaning Wire	1
⑯	Autoclave Plug	1
⑰	TA Bulb (For Optic Motor)	1
⑱	Spare Fuse	2

^(*) Handpiece will be attached suitable one, ^(*) Handpiece Dependent

* One of that handpieces/motor should be packed.

3. Control Unit with an Irrigation Pump

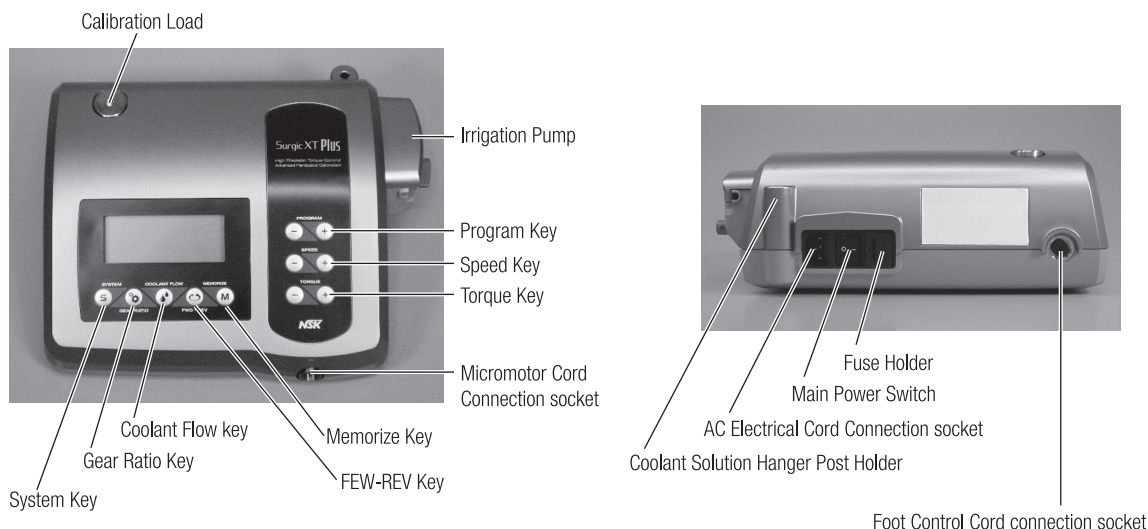

Description of Operation

◆ Keys on the Control Unit

- (1) Program Key
Use to Cycle through available programs. Press [+] key to ascend and [-] key to descend program number. You will find all program numbers sequentially by pressing keys.
- (2) Speed Key
Use to set the Micromotor speed. Press [+] key to increase, and [-] key to decrease speed. (When the upper and lower speed limits are reached an audible alarm 'beep' is sounded).
- (3) Torque Key
Use to set the torque range. Press [+] key to increase and [-] key to decrease torque range. (When the upper and lower torque range limits are reached an audible alarm 'beep' is sounded). The torque range setting should be selected according to the attached handpiece gear ratio.
- (4) System Key
Use to activate calibration cycle of the handpiece before use.
- (5) Gear Ratio Key
Use to set gear ratio of the attached handpiece before use. Repeat press this key until the LCD display indicates the correct gear ratio of the handpiece.
- (6) Coolant Flow Key
Use to select 6 levels of coolant solution flow from 0 to 5, repeat press key to cycle through coolant flow levels.
- (7) FWD-REV Key
Use to select the direction of rotation. Press this key once to change the rotational direction. (Once in reverse the Control Unit audibly warns with a 'beep')
- (8) Memorize Key
Use to memorize the program parameters set by the operator. Press & hold this key for approx. 1 second to memorize parameters. When beep sounds, the new program parameters have been memorized.

◆ LCD display on the Control Unit Console

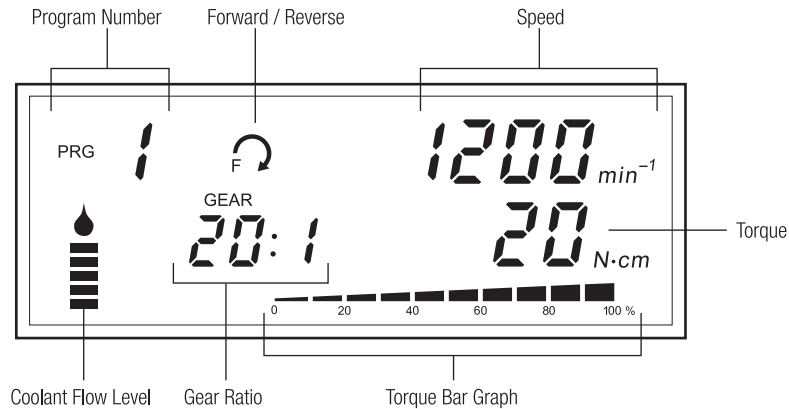

(1) Coolant Flow Level

Displays the selected coolant solution flow level; the selected Flow level is indicated by 1 to 5 levels of illuminated indicators. No illumination indicates when the Coolant Solution Flow is off.

(2) Program Number

Displays the selected program number.

(3) Gear Ratio

Displays the selected gear ratio of the handpiece.

(4) Forward/Reverse Indicator

Displays the selected direction of the Micromotor.

(5) Speed

Displays the selected speed.

Depressing Foot Control: Rotation speed of the motor displayed on the LCD (Assuming the correct gear ratio is selected)

Without pressing Foot Control : Max Rotation preset setting displayed on the LCD

(6) Torque: Displays the selected torque.

* When using the 1:1 direct drive or Speed increasing handpiece, the torque is not displayed. (This function is appropriate for 2:1 increase speed handpiece or more)

(7) Torque Bar Graph

Display the actual operating torque range. When all bars illuminate, the operating torque is at maximum. When bars are half illuminated then the operating torque is approximately 50% of the preset torque.

⚠ CAUTION

The LCD display panel is produced from liquid crystal and should always be treated with care.

4. Foot Control

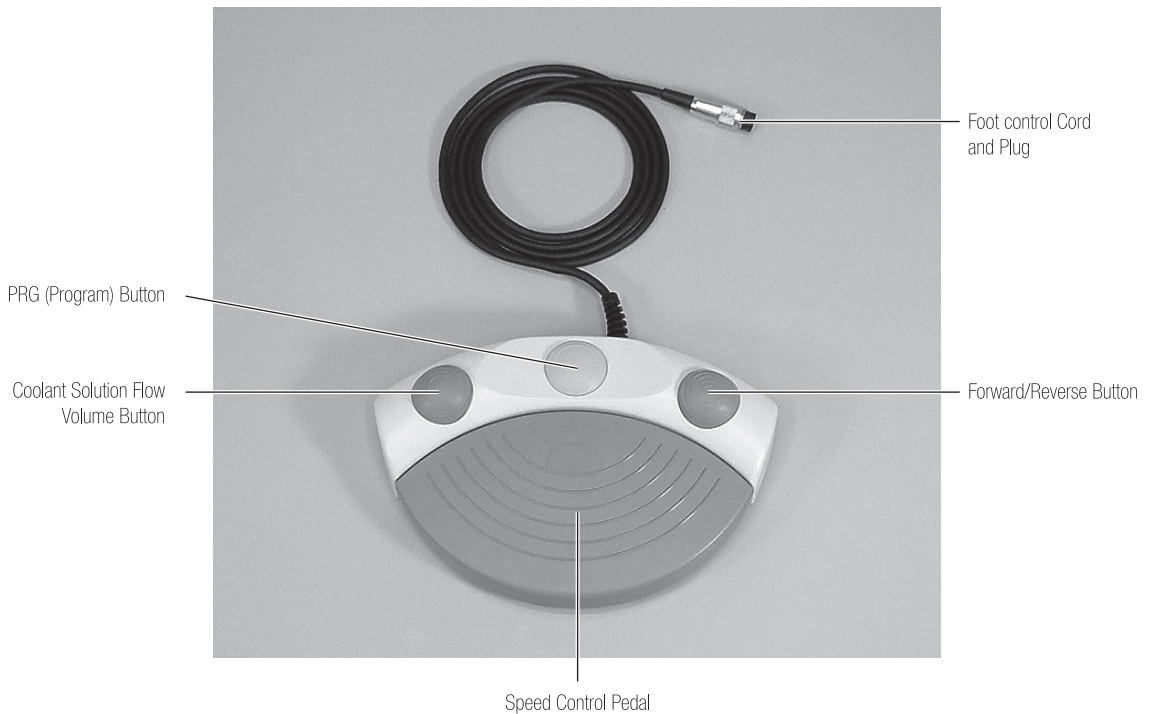

(1) Coolant Solution Flow Volume Button

Use to select 6 levels of coolant solution flow from 0 to 5; each level may be increased by one step pressing this button. If you press this button in level 5, it returns to level 0.

(2) PRG (Program) Button

Use to select the desired program number. Program numbers will always ascend each time this button is pressed and released. To descend, press and hold for 1 second then release.

(3) Speed Control Pedal

Used to start and stop the Micromotor and to control the speed during operation. The Micromotor operational speed is directly proportional to the position of the foot control, up to the preset maximum.

(4) Forward/Reverse button

Used to change the rotational direction of the Micromotor. Push once to change the rotational direction.

5. Installation

5-1 Connecting the Motor Cord

Align the [▲] mark on the Micromotor cord with [▼] mark on the Control Unit; push the Base of Micromotor Cord Plug into the socket until the locking joint 'clicks' into place.

To disconnect the plug; pull back the Lock Joint, pull further to disconnect the cord (Fig. 2).

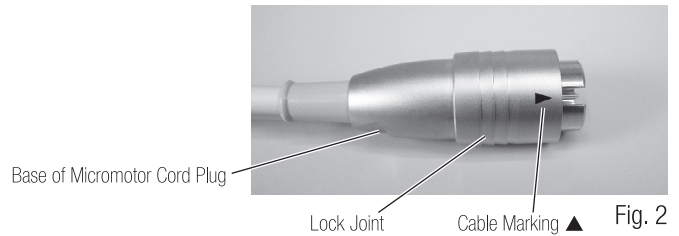

5-2 Connecting the Foot Control

Face the screw on the Foot Control Cord Plug downward then insert the plug into the Foot Control Cord connector socket on the Control Unit. Secure the plug by fastening the Lock Nut. Refer Figs. 3 & 4.

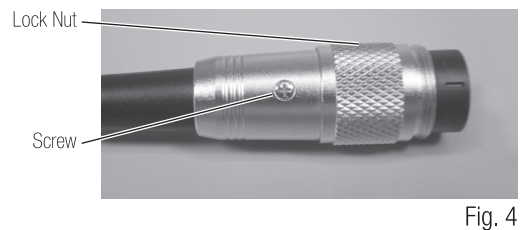
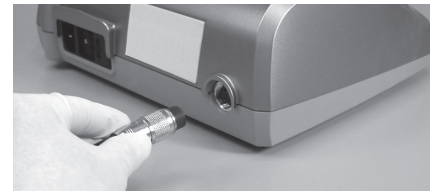

5-3 Connecting the AC Electrical Cord

Correctly align then insert the AC Electrical Cord into the AC Electrical Cord Connection at the back of the Control Unit (Fig. 5).



5-4 Installing the Irrigation Tube

Mount the Irrigation tube. Ensure the pump cover lever is in the 'OPEN' position, with the Irrigation tube 'Needle' towards the backside of the Control Unit. Position the stoppers of the tube assembly in to the Tube Guide securely. (Fig. 6)

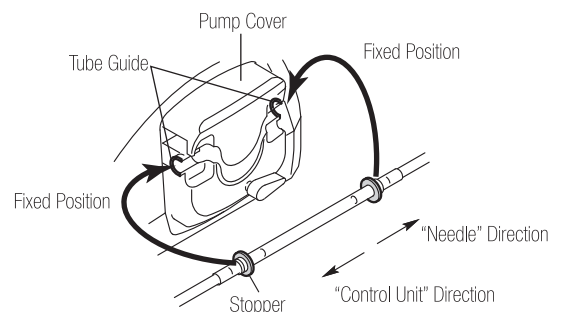

CAUTION

Make sure that the tube is securely set on the rollers when closing the Pump Cover. If the tube is not correctly positioned on the Rollers and the cover is closed, the tube could be cut or sheared. (Fig. 7)

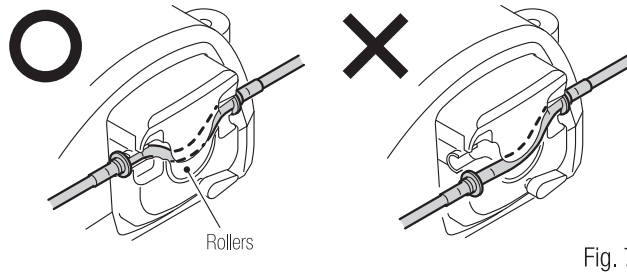

Fig. 7

After the tubes are correctly positioned, close the Pump Cover by turning the Pump Cover Lever to the 'CLOSE' position (180 degrees counterclockwise) (Fig. 8 & 9)

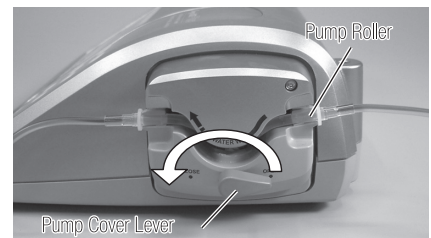

Fig. 8

5-5 Mounting the Coolant Solution Hanger Post

Mount the Coolant Solution Hanger Post onto the Holder on the Control Unit, the post will only fit into one position (Fig10). Place the bottle as shown in Fig. 11.

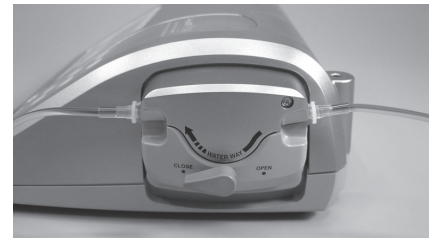

Fig. 9

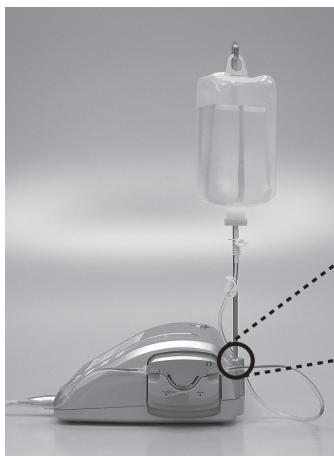

Fig. 11

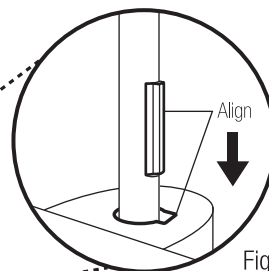

Fig. 10

5-6 Insertion of the irrigation Tube

1) Close the Tube Clamp, between the Irrigation Tube Needle and the Irrigation Pump, as shown in Fig.12.

2) Insert the Irrigation Tube Needle into the Bottle Cap. (Fig.13)

3) Open the Tube Cap to supply air into the bottle. (Fig.14)

4) Open the Tube Clamp.

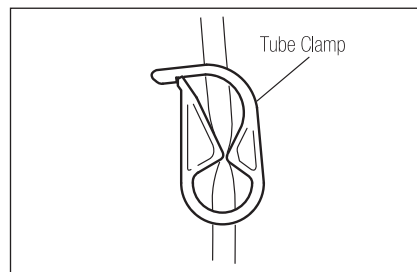

Fig. 12

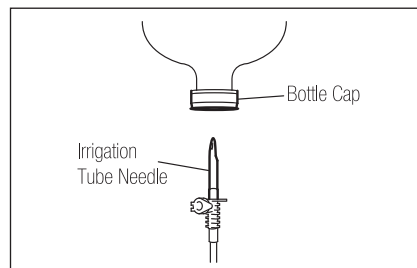

Fig. 13

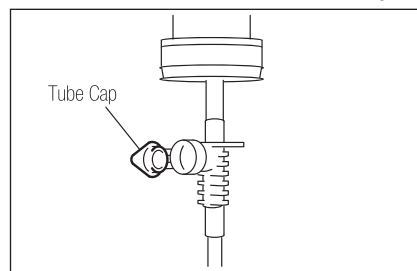

Fig. 14

CAUTION

Do not operate the Irrigation Pump if the tube is bent or the Tube Clamp is in the closed position. This could cause the tube to burst or slip out of the bottle.

5-7 Compatibility check of Internal Irrigation Nozzle/Drill

Internal irrigation nozzles accompanied with this product; is not necessarily fitted into all the drills on the market.

Follow the instructions given below for confirmation prior to use.

Failure to do so or to fit the internal irrigation nozzle into drills may cause a leakage of saline solution, which will result in problems such as rust or sudden stop of equipment during use.

Instructions:

1) Attach a bottle of saline solution to the Control Unit.

2) Connect the Internal Irrigation Nozzle into the tip of the irrigation tube.

3) Insert the Internal Irrigation Nozzle into the drill from the back (Fig 15).

4) Purge at "Maximum" for 5 seconds.

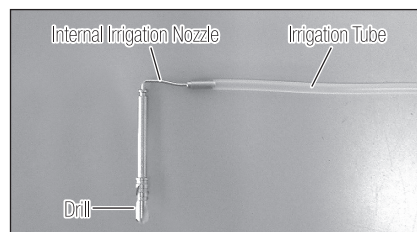

Fig. 15

Points to be checked :

◇ Cleanliness of the saline solution coming out from the drill; if solution is colored there could be rust inside of the drill. If so renew the drill.

◇ Water Flow; if the flow is low and/or the flow from the drill is asymmetric, renew the drill.

◇ No water leakage between Internal Irrigation Nozzle and drill

Before use, ensure no water is leaking from the entry point of irrigation nozzle, a broken seal or no seal in the drill may be the cause. Replace the drill even if its new, saline solution ingress into handpiece will cause malfunction.

⚠ CAUTION

If malfunction such as a leakage of saline solution from the back of Contra Head is detected during use, stop using and perform some troubleshooting.

5-8 Irrigation Nozzle Attachment

X-SG20L/SG20 has 3 irrigation methods available depending on tool and application; External, Internal or both, For installation detail, refer to the attached handpiece Operation Manual.

5-9 Attaching the Tube Holder

Use the Motor Cord as a strain relief for the 'Irrigation Tube'. It is easier to insert Motor Cord first, then the Irrigation Tube (Fig.16).

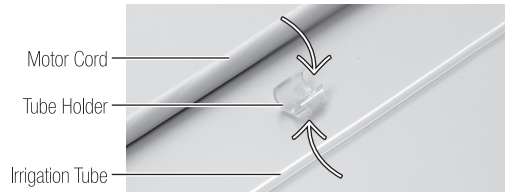

Fig. 16

6. Operation

6-1 Programming the Micromotor Operation

The Control Unit can memorize 8 programs. Each program includes the following functions which will be automatically performed when the appropriate program number is selected.

- ◇ Gear ratio of contra angle handpieces
- ◇ Speed
- ◇ Direction of rotation
- ◇ Torque upper limit
- ◇ Coolant Solution Flow

- (1) Turn on the power by pushing the Main Power Switch toward [-]; on power up program #1 is displayed by default.
- (2) Select a program number by using either step (a) or step (b):
 - (a) Press the [Program] Key on the Control Panel until the desired program number is displayed.
 - (b) Press the [Program] button on the Foot Control until the desired program number is displayed.
- (3) Selecting the Gear Ratio of the handpiece relevant to the program; Press the [Gear Ratio] Key to select the gear ratio of the handpiece (Gear Ratio will display on the LCD).
- (4) Set the required max operating speed by pressing the [Speed] Key. Each time this Key is pressed display changes to the next speed level. By pressing this Key for more than 1 second brings the speed quickly to the next level until the speed display reaches its upper or lower limit.
 - When the speed setting reaches the upper or the lower limit, an audible beep is heard and the speed setting cannot be changed any further.
- (5) Set the torque upper limit by pressing the [Torque] Key on the Control Panel. Each time this Key is pressed display changes to the next torque level. By pressing this Key for more than 1 second brings the torque quickly to the next level until the torque display reaches its upper or lower limit.
 - When the torque setting reaches the upper or the lower limit, an audible beep is heard and the torque setting cannot be changed any further.
- (6) Set the rate of the Coolant Solution Flow volume by pressing the [Coolant Flow] Key. The rate of Coolant Solution Flow volume has 6 Flow rates (0-5) (0 = no coolant Flow).

Power Switch Symbol Mark	○	I
Function	OFF	ON

(7) Memorize setting; after completing steps 2 - 6 press and hold [Memorize] key until beep is heard. The beep confirms that the programming is completed. If you hear a short beep when the [Memorize] Key is first pressed ignore this sound and keep the [Memorize] Key depressed until a long beep is heard.

* Repeat the above steps 21 - 7 to program any one of the 8 available programs.

6-2 Calibration Function

The rotation resistance of a handpiece depends on the handpiece model, condition, and internal wear of the handpiece gears. This Control Unit incorporates an automatic function to recognize the level of the resistance of the attached handpiece and Micromotor.

CAUTION

- This equipment is optimized to obtain the highest accuracy at a gear ratio of 1:20 (X-SG20L/SG20) when using another gear ratio, note that the accuracy decreases with an increase in the ratio relative to 1:20.
- Micro saw handpiece should not be calibrated.
- Calibration should be performed only on NSK handpiece.

- (1) Connect the Micromotor to the Control Unit, Attach the handpiece to the Micromotor. Turn the power 'ON'.
- (2) Attach the calibration bur to the handpiece. (Fig. 17)
- (3) Press the [Gear Ratio] Key and select the gear ratio of the handpiece.
- (4) Press & hold the [SYSTEM] Key for two seconds initiates the calibration mode. The LCD displays "CAL ON-cm."
- (5) Torque Calibration (no load): Ensure the calibration bur is inserted and free to rotate (Fig. 18). Press the [SYSTEM] Key; after a notification sound the handpiece will illuminate (Optic Handpiece only) and the bur will slowly rotate. On completion the motor will stop the calibration cycle will continue to the next test (Under load).
- (6) On the screen "19.6N-cm" is displayed: align and Insert the Calibration Bur to the Calibration load, Holding the bur vertically (Fig 19) press the [SYSTEM] key, after a notification sound, the calibration will automatically start, handpiece will illuminate (Optic Handpiece only) and the bur will slowly rotate the load cell, on completion the motor will stop, "donE" is displayed, the calibration cycle will continue to the speed checks.

* If "FAIL" is displayed the calibration at that point has failed.
Pressing the [SYSTEM] Key returns the failed aiLCD process back to the start, a reattempt can be made on that point.

CAUTION

During a process, it is important to hold the Calibration Bur vertically without applying any forcible power. Making the Calibration Bur tilt or pressing it may cause a loss in accuracy.



Fig. 17



Fig. 18

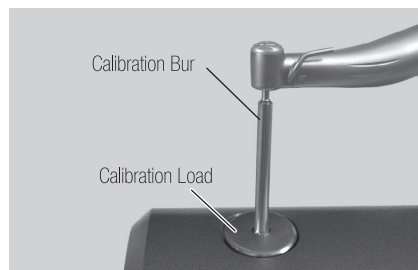

Fig. 19

- (7) Speed calibration: “CAL Lmin⁻¹” is displayed. Ensure the calibration bur is removed and the handpiece is free to rotate (Fig. 20) ; Press the [SYSTEM] Key after a notification sound, the calibration is automatically started, the handpiece will illuminate (Optic Handpiece only) and start to rotate, it will automatically cycle through to the highspeed test. On completion the motor stops “donE” is displayed the calibration is complete, normal operation mode will continue.



Fig. 20

⚠ CAUTION

During the process, the rotational speed is automatically increased and finally rotates at high speed. Significant care should be taken to avoid danger.

- (8) Calibration of the handpiece is completed.

⚠ Calibration fail example

- Extreme gear abrasion and mechanical loss can exceed the control limits. Correct data cannot be obtained during calibration cycle and the calibration will fail. In this case, request repair.
- Calibration fail; if the calibration bur makes contact with something during no load calibration or no load is erroneously applied during load calibration.

6-3 Optical Illumination option On/Off (X-SG20L Only)

* Factory initialized settings lamp 'ON'

(1) Selection

- 1) Lamp OFF: Hold the [System] Key and turn the power 'ON'; Two beeps notifies the operator the lights are 'OFF'
- 2) Lamp ON: Press the [System] Key and turn the power 'ON'; One beeps notifies the operator the lights are 'ON'

(2) Confirmation

- Confirm whether the lamp of the motor lights or not by the beep issued when turning the power ON.
- Long beep once: “Lights up”
 - Short beep twice: “Does not light up”

⚠ NOTICE

- Repeat the above procedures when restoring operation.
- The lamp status will remain set even if the power is switched “OFF” and ‘ON.
- This function is only applicable for an optic handpiece, for non optic handpieces us in “lamp off” mode.

6-4 Standard Operation

All standard operational functions can be control LCD at the Foot Control.

- (1) Turn on the Main Power Switch: The Control Unit is ready to perform the Program.
- (2) Select the desired program number: Step on the Foot Control PRG (Program) Button and the program display ascends to the next program number. Pressing the PRG (Program) Button for one second more will descend the to the next program number.
- (3) Verify the details of the program on the display. The largest numerals displayed are the speed and torque settings.

- (4) Operating the Micromotor : Step on the speed control pedal in the middle of the Foot Control the Micromotor will start to run. The Coolant Pump will also run (if programmed). Speed increases as the pedal is depressed. When the Speed Control Pedal is fully depressed the speed reaches the maximum preset value.

CAUTION

Using the Micromotor with light 'ON' for more than 15 minutes continuously, the light will become hot. In such cases, stop using the Micromotor till the light part cools down, or use the Micromotor without turning on the light.

- (5) Activation of the torque limiter: During use, when the drilling load reaches the preset torque upper limit, the integrated torque limiter automatically activates to prevent over torque. When the torque limiter activates, the motor stops after beeping for 1 second. To reactivate the Micromotor, release the speed control pedal and depress it again.
- (6) Stopping the Micromotor: Release the Foot Control Pedal, and the Micromotor will automatically stop.
- (7) Reversing the Micromotor rotational direction: To reverse direction of the Micromotor (and burr) simply step on the Foot Control Forward/Reverse button. A warning beep can be heard when the rotational direction is in reverse mode.

7. Care and Maintenance

7-1 Protection Circuit

An electronic circuit breaker automatically functions to protect the Micromotor and the Control Unit if the Micromotor is ever overloaded. Power supply to the Micromotor will automatically be terminated an Error code will be displayed on the Control Unit.

◆ Resetting the Protection Circuit

To reset the Protection Circuit, release and then depress the Speed Control Pedal.

7-2 Error Codes

If an operational problem occurs the display will show an error code allowing immediate problem diagnosis.

Error Code	Error Mode	Cause of Error	Remedy
E0	System Error	Erroneous memory. Memory failure.	Request repair.
E1	Excessive Current Detected	Extended use under heavy load. Short circuit in the micromotor.	Electrical contact may be insufficient. Securely re-connect the Motor Cord. When an error cannot be eliminated, request repair.
E2	Excessive Voltage Detected	Micromotor cord failure.	
E3	Motor Sensor Error	Micromotor sensor failure (Hall IC). Micromotor Cord failure.	Request repair. Make sure to put an Autoclave Plug when autoclaving it.
		Ingress of water into a Motor.	

Error Code	Error Mode	Cause of Error	Remedy
E4	Control Unit Interior Over-heating Error	Overheating by extended use under heavy load. Operation of the Control Unit under an extremely high temperature.	Allow it to cool down before use. Since heat is sufficiently radiated, periphery of the main Control Unit should be well-ventilated wherever possible. When an error cannot be eliminated, request repair.
E5	Breaking Error	Abnormal voltage generated in the start / stop switch circuit. Failure in the start / stop switches circuit.	When rotation and stop are repeated in short frequencies, a circuit may be activated which limits acceleration at start. Wait a few seconds and then use. When an error cannot be eliminated, request repair.
E6	Motor Rotation Failure Error	Handpiece attachment failure. Micromotor failure.	The chuck may be opened, or may not be sufficiently closed. Securely close the chuck. When an error cannot be eliminated, request repair.
E7	Pump excess voltage	The Irrigation tube is incorrectly fitted and loading the pump roller . The pump fails.	Check the Irrigation tube. If an error code is displayed even when the Irrigation tube is normal, request repair.
E8	Pump excess current		
E9	Foot Control abnormality	Connection failure of the connector. Failure of the inside of the Foot Control	Check the connection state of the connector. The error code is displayed even when the connector is normally connected, request repair.
E10	Lamp excess voltage (Optic Motor)	Failure of lamp circuit.	Request repair.
E11	Lamp excess current (Optic Motor)	Check if the saline solution hasn't penetrated the motor lamp.	Remove the saline solution completely.
		Failure of lamp circuit.	Request repair.

7-3 Fuse Replacement

If the Control Unit does not function, check the fuses (Fuse Box lock located on the rear of the Control Unit). To access the Fuse, use a pointed tool push on the fuse locking latch and the drawer will spring open (Fig. 21).

Fuse Ratings

120V	T3.15AL	250V
230V	T1.6AL	250V

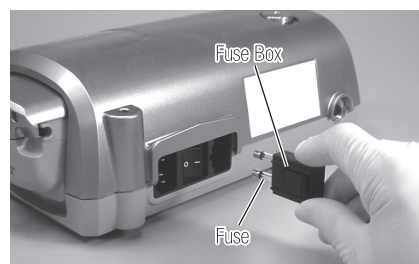

Fig. 21

7-4 Replacement of the Bulb (Optic Motor ONLY)

- 1) Loosen Motor Housing and detach from the motor, and remove the old light bulb using the small pin, like the precision screwdriver. (Fig. 22)
 - 2) Align and insert the connector of the new bulb into the Socket Hole securely. Screw the motor housing securely to the motor.
- * Optional Bulb: TA Bulb (Pack of 3) Order No. Y900 132

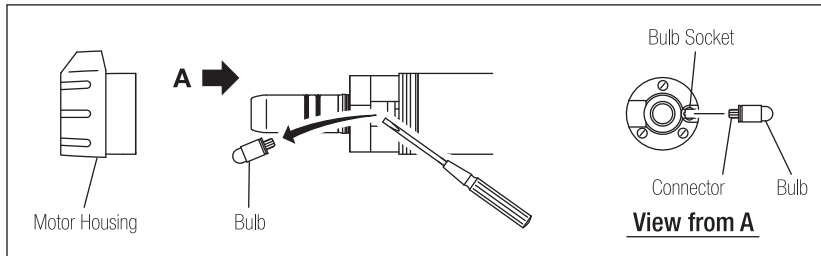

Fig. 22

CAUTION

- Make sure the power 'OFF' (remove the AC Electrical cord)
- Do not touch the glass of new bulb.

7-5 Maintenance of the Control Unit and Foot Control

If blood or saline solution has stained the Control Unit or Foot Control, remove the AC Electrical Cord; wipe Control Unit or Foot Control with a damp cloth, then with an alcohol-absorbed cloth.

7-6 Maintenance of the Handpiece Attachment

For detail, refer to the attached handpiece Operation Manual.

8. Sterilization

- Autoclave sterilization is recommended.
- Autoclave sterilization is required for the first time use and after each patient as noted below.

The following items can be autoclaved.

- Implant Handpiece
- Micromotor with Motor Cord (Including the Motor Housing)
- TA Bulb
- Handpiece Stand
- Internal Irrigation Nozzle
- Tube Holder
- Nozzle Holder
- Autoclave Plug
- Calibration Bur

CAUTION

Only Items Specified above can be autoclaved



Implant Handpiece can be cleaned and disinfected with a Thermo-Disinfector.

[Autoclaving]

- 1) Remove blood and debris from the handpiece.
- 2) Clean inside the handpiece; by using the spray lubricant (refer to "7-6. Maintenance of the Handpiece Attachment").
 - Do not attempt to spray lubricant into the Micromotor.
 - Attach the Autoclave Plug to the Micromotor. (Fig. 23 & 24)
- 3) Place those in autoclave pouch (not included in the package) and seal it.
- 4) Autoclave up to max. 135°C. (Autoclave for 20 min. at 121°C, or 15 min. at 132°C.)
- 5) Keep the handpiece in the autoclave pouch to keep it clean until you use it.

* Sterilization at 121 °C for more than 15 minutes is recommended by EN13060 or EN554.

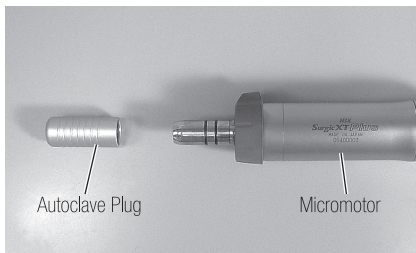

Fig. 23

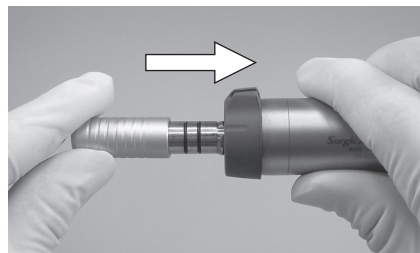

Fig. 24

⚠ Caution for Autoclaving

- Clean and lubricate the handpiece before autoclaving. Autoclaving a handpiece stained with blood or debris could cause damage to the handpiece.
- Do not lubricate the Micromotor.
- Do not disconnect the Motor Cord from the Micromotor.
- The Irrigation tube is a single use disposable type and cannot be autoclaved.

9. Optional Accessories

Part No.	Description	Remarks
C823 752	Y-Connector	Used for branching the internal and external coolant irrigation.
Y900 113	Irrigation tube (Pack of 5)	For replacement tube use.
20000396 (for X-SG20L) 20000357 (for SG20)	Internal Irrigation Nozzle	Supplied as standard accessory items.
10000324	Nozzle Holder	Supplied as standard accessory.
U370 246	Tube Holder	Supplied as standard accessory for Irrigation Nozzle.
Z182 100	PANA SPRAY Plus	For High & Low speed handpieces.

10. Specifications

10-1 Control Unit

Model	Surgic XT Plus
Type	NE179
Power Supply Voltage	AC120 / 230V
Frequency	50/60Hz
Power Consumption	52VA
Max. Pump Output	75mL / min. (.02 gal/min)
Dimensions	W268 x D230 x H103mm

10-2 Micromotor

Model	SGL50M (with Optic)	SG 50MS (without Optic)
Type	E295-050	E290-050
Speed Range	200 - 40,000min ⁻¹ (rpm)	
Input Voltage	DC30V	
Dimensions	ø24 x L105mm (Without the Motor Cord)	

10-3 Foot Control

Type	FC-51
Code length	2M

10-4 Handpiece

Model	X-SG20L	SG20
Max. Rotation Speed	40,000min ⁻¹	
Chuck Type	Push Bottom Chuck	
Gear Ratio	20:1 Reduction	
Spray Type	External, Internal*	
Bur/Drill Type	ø2.35Surgical bur-drill (ISO3964)	
Bur/Drill Length	11.6mm	
Max. bur length	36mm	
Max diameter	ø4.7mm	
Optic	Glass Rod Optic	—

Do not exceed the rotation speed that bur manufacture recommends. Adjust the rotation speed which bur manufacture recommend, if you use the allowable rotation speed is less than 120,000min⁻¹.

* If you use internal irrigation system drills.

11. Disposing Product

Consult with dealer from whom you purchased it about waste disposal.

Symbols



TUV Rhineland of North America is a Nationally Recognized Testing Laboratory (NRTL) in the United States and is accredited by the Standards Council of Canada to certify electro-medical products with Canadian National Standards.



This product is designed not to become the ignition source in air and flammable anesthetic gas.



The EU directive 93/42/EEC was applied in the design and production of this medical device.

0197



Protected against the effects of continuous immersion in dust and water.



Dispose of this device and its accessories via methods approved for electronic device and in compliance with the Directive 2002/96/CE



Type BF applied part



See Operation Manual



Marking on the outside of Equipment or Equipment parts that include RF transmitters or that apply RF electromagnetic energy for diagnosis or treatment.

Guidance and manufacturer's declaration - Electromagnetic Emissions.		
Surgic XT Plus is intended for use in the electromagnetic environment specified below. The customer or the user of the Surgic XT Plus should assure that is used in such an environment. Guidance and manufacture's declaration electromagnetic emissions.		
Emissions test	Compliance	Electromagnetic environment - guidance
RF emissions CISPR11	Group 1	Surgic XT Plus uses RF energy only for its internal function. Therefore, its RF emissions are very low and are not likely to cause any interference in nearby electronic equipment. Surgic XT Plus is suitable for use in all establishments, including domestic establishments and those directly connected to the public low-voltage power supply network that supplies buildings used for domestic purposes.
RF emissions CISPR11	Class B	
Harmonic emissions IEC61000-3-2	Class A	
Voltage fluctuations/flicker emissions IEC61000-3-3	Complies	

Guidance and manufacturer's declaration - Electromagnetic Immunity			
Surgic XT Plus is intended for use in the electromagnetic environment specified below. The customer or the user of the Surgic XT Plus should assure that it is used in such an environment.			
Immunity test	IEC60601 test level	Compliance level	Electromagnetic environment - guidance
Electrostatic discharge (ESD) IEC61000-4-2	± (2, 4, 6) kV contact ± (2, 4, 8) kV air	± (2, 4, 6) kV contact ± (2, 4, 8) kV air	Floors should be wood, concrete or ceramic tile. If floors are covered with synthetic material, the relative humidity should be at least 30%.
Electrical fast transient/burst IEC61000-4-4	± 2kV for power supply lines ± 1kV for input/output lines	± 2kV for power supply lines ± 1kV for input/output lines	Mains power quality should be that of a typical commercial or hospital environment.
Surge IEC61000-4-5	± 1kV differential mode ± 2kV common mode	± 1kV differential mode ± 2kV common mode	Mains power quality should be that of a typical commercial or hospital environment.
Voltage dips, short interruptions and voltage variations on power supply input lines IEC61000-4-11	<5% Ut (>95% dip in Ut) for 0.5 cycle 40% Ut (60% dip in Ut) for 5 cycles 70% Ut (30% dip in Ut) for 25 cycles <5% Ut (>95% dip in Ut) for 5 sec	<5% Ut (>95% dip in Ut) for 0.5 cycle 40% Ut (60% dip in Ut) for 5 cycles 70% Ut (30% dip in Ut) for 25 cycles <5% Ut (>95% dip in Ut) for 5 sec	Mains power quality should be that of a typical commercial or hospital environment. If the user of the Surgic XT Plus requires continued operation during power mains interruptions, it is recommended that the Surgic XT Plus be powered from an uninterruptible power supply or a battery.
Power frequency (50/60Hz)magnetic Field IEC61000-4-8	3A/m	3A/m	Power frequency magnetic fields should be at levels characteristic of a typical location in a typical commercial or hospital environment.
NOTE 'Ut' is the AC mains voltage prior to application of the test level.			

Guidance and manufacturer's declaration - electromagnetic immunity			
Surgic XT Plus is intended for use in the electromagnetic environment specified below. The customer or the user of the Surgic XT Plus should assure that it is used in such an environment.			
Immunity test	IEC60601 test level	Compliance level	Electromagnetic environment - guidance
Conducted RFI EC61000-4-6	3V rms 150 kHz to 80MHz	3V rms	Portable and mobile RF communications equipment should be used no closer to any part of the Surgic XT Plus, including cables, than the recommended separation distance calculated from the equation applicable to the frequency of the transmitter.
Radiated RFI EC61000-4-3	3V/m 80MHz to 2.5 GHz	3V/m	<p>Recommended separation distance</p> $d = 1.2 \sqrt{P}$ $d = 1.2 \sqrt{P} \quad 80\text{MHz to } 800\text{MHz}$ $d = 2.3 \sqrt{P} \quad 800\text{MHz to } 2.5\text{GHz}$ <p>Where P is the maximum output power rating of the transmitter in watts (W) according to the transmitter manufacturer, and (d) is the recommended separation distance in meters (m).</p> <p>Field strengths from fixed RF transmitters as determined by an electromagnetic site survey⁹⁸ should be less than the compliance level in each frequency range⁹⁸.</p> <p>Interference may occur in the vicinity of equipment marked with the following symbol:</p> 
NOTE 1 At 80MHz and 800MHz, the higher frequency range applies.			
NOTE 2 These guidelines may not apply in all situations. Electromagnetic propagation is affected by absorption and reflection from structures, objects and people.			
<p>a Field strengths from fixed transmitters, such as base stations for radio (cellular/cordless) telephones and land mobile radios, amateur radio, AM and FM radio broadcast and TV broadcast cannot be predicted theoretically with accuracy. To assess the electromagnetic environment due to fixed RF transmitters, an electromagnetic site survey should be considered. If the measured field strength in the location in which the Surgic XT Plus is used exceeds the applicable RF compliance level stated above, the Surgic XT Plus should be observed to verify normal operation. If abnormal performance is observed, additional measures may be necessary, such as reorienting or relocating the Surgic XT Plus.</p> <p>b Over the 150kHz to 80MHz frequency range, the field strength should be less than 3V/m.</p>			

Cables and accessories	Maximum length	Complies with
Micromotor with Motor Cord	2m	RF emissions, CISPR11: Class B/ Group 1
Foot Controller with Cord	2m	Harmonic emissions: IEC61000-3-2
AC Electrical Cord	2m	Voltage fluctuations/ flicker emission: IEC61000-3-3
		Electrostatic discharge (ESD): IEC61000-4-2
		Surge: IEC61000-4-5
		Voltage dips, short interruptions and voltage variations on power supply input lines: IEC61000-4-11
		Power frequency (50/60Hz) magnetic field: IEC61000-4-8
		Conducted RF: IEC61000-4-6
		Radiated RF: IEC61000-4-3

Recommended separation distances between portable and mobile RF communications equipment and the Surgic XT Plus.			
The Surgic XT Plus is intended for use in an electromagnetic environment in which radiated RF disturbances are controlled. The customer or the user of the Surgic XT Plus can help prevent electromagnetic interference by maintaining a minimum distance between portable and mobile RF communications equipment (transmitters) and the Surgic XT Plus as recommended below, according to the maximum output power of the communications equipment.			
Rated maximum output power of transmitter W	Separation distance according to frequency of transmitter m		
	150kHz to 80MHz $d = \left[\frac{3.5}{V_1} \right] \sqrt{P}$	80MHz to 800MHz $d = \left[\frac{3.5}{E_1} \right] \sqrt{P}$	800MHz to 2.5GHz $d = \left[\frac{7}{E_1} \right] \sqrt{P}$
0.01	0.12	0.12	0.23
0.1	0.38	0.38	0.73
1	1.2	1.2	2.3
10	3.8	3.8	7.3
100	12	12	23
For transmitters rated at a maximum output power not listed above, the recommended separation distance 'd' in meters (m) can be estimated using the equation applicable to the frequency of the transmitter, where 'P' is the maximum output power rating of the transmitter in watts (W) according to the transmitter manufacturer.			
NOTE 1 At 80 MHz and 800 MHz, the separation distance for the higher frequency range applies.			
NOTE 2 These guidelines may not apply in all situations. Electromagnetic propagation is affected by absorption and reflection from structures, objects and people.			